

FLASH TRIGGER 1  
PJ-307  
J1

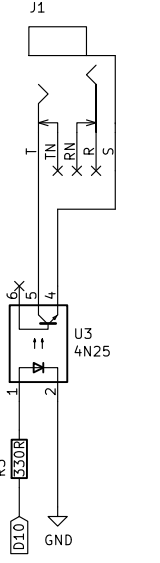

FLASH TRIGGER 2  
PJ-307  
J2

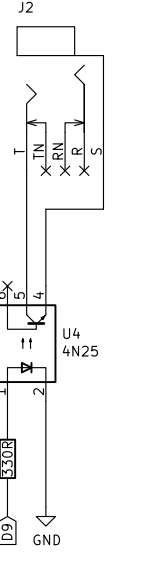

FLASH TRIGGER 3  
PJ-307  
J3

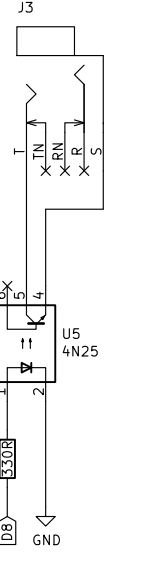

CAMERA  
PJ-307  
J4

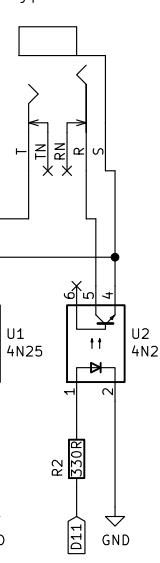

Solenoid#1  
J5  
RCJ-04x

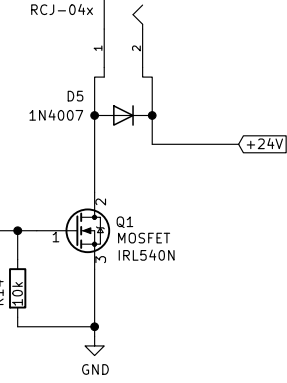

Solenoid#2  
J6  
RCJ-04x

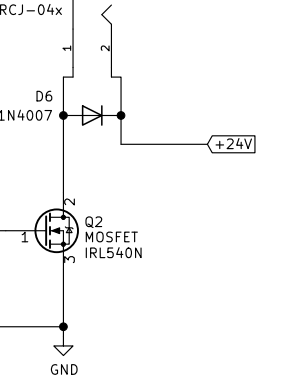

Solenoid#3  
J7  
RCJ-04x

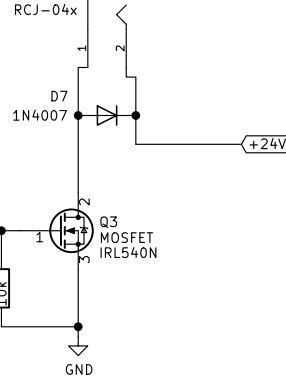

Solenoid#4  
J8  
RCJ-04x

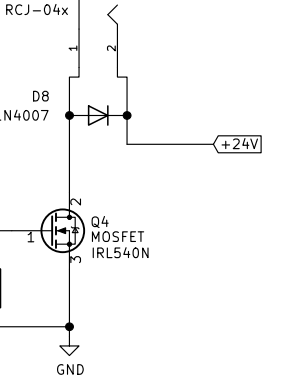

Solenoid#5  
J9  
RCJ-04x

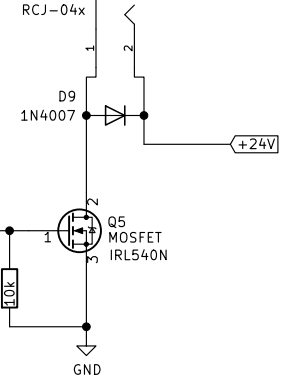

Solenoid#6  
J10  
RCJ-04x

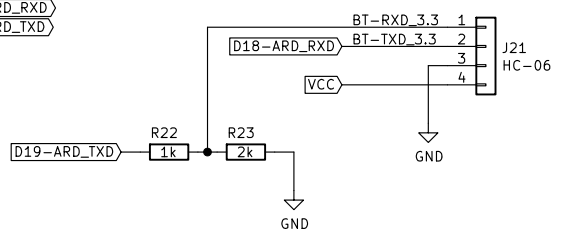
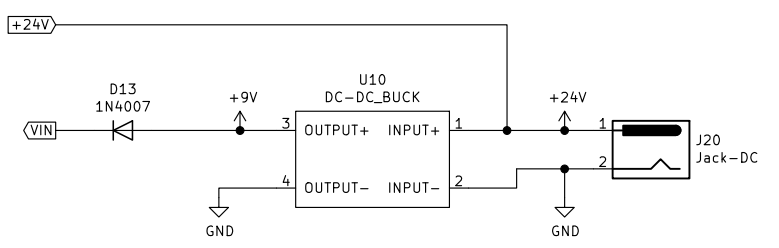
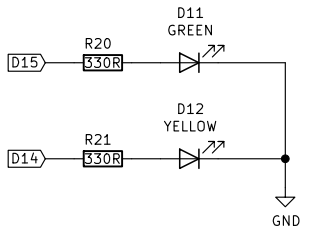
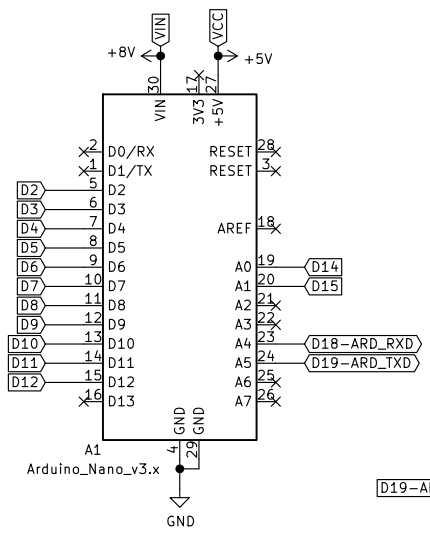
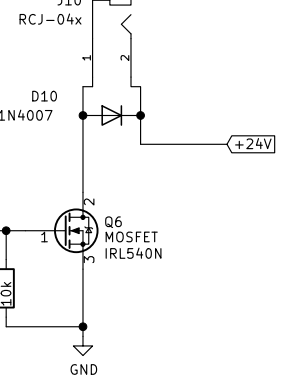

See [www.dropcontroller.com](http://www.dropcontroller.com) for details

Sheet: /  
File: DropController.sch  
**Title: dropController V3**  
Size: A3 Date: 2020-02-28 Rev: PCB 1.52  
KiCad E.D.A. kicad (5.1.4)-1 Id: 1/1